



**IMAC Systems, Inc.**  
90 Main Street, PO Box 1605  
Tullytown, PA 19007  
Tel. 1-800-955-4GAS  
(215) 946-2200  
Fax: (215) 943-2984

[www.imacsystems.com](http://www.imacsystems.com)

## CL31 Series Commercial Regulator



Advanced Metering  
and Regulation  
Technology at Work

# Features

- The CL31 regulator can produce substantial savings for users in lower initial costs, lower installation costs and lower maintenance costs. Optimum valve design limits over boosting or rapid drop-off as the capacity requirement changes, including fast on-off loads.
- Controlled size pilot breather orifice eliminates pulsation and provides normal breathing operation
- "Stop stem" in pilot insures token internal relief valve operation.
- No special start-up procedures

# Benefits

- Constant pressure loading provides "Fixed Factor" Measurement Accuracy
- Internal bleed
- Light closing spring for low lock-up
- Wide outlet pressure range (1 psig to 20 psig)
- One adjustable outlet spring (N version only)
- Built in strainer screen in pilot regulator (N version only)
- Extremely light weight
- Compact design
- Safety advantage of second gas tight lock-up seat with IM Version

# Applications

The CL31 was designed for systems requiring highly accurate pressure regulation such as:

- A) Utility "Fixed-Factor" metering of relatively small loads (up to 4000 scfh)
- B) Industrial Heating equipment requiring constant high burner pressures (1 psig to 20 psig)

## Option Designations

**CL31N** - The CL31N is a constant pressure loaded regulator that utilizes a pilot with no internal relief (N). This regulator can be used where psig to psig regulation is required with no internal relief.

**CL31R** - The CL-31R is a constant pressure loaded regulator equipped with a pilot internal relief valve. The pilot relief valve is not designed for "full capacity" relief, but rather to limit the loading chamber pressure to a safe value in the event of failure.

**CL-31IMN (see page 6 for Operating Schematic)** - The CL-31IMN is a constant pressure loaded regulator featuring Internal Monitoring (IM) operation with no pilot internal relief (N). It provides the important added advantage of a second, bubble-tight lock-up seat in series with the primary seat. If the primary seat fails to close or control the gas flow, the Internal Monitor seat assumes control of the downstream gas pressure.

**CL-31IMR (See page 6 for Operating Schematic)** - The CL-31MR provides the same features as the 'IMN' model but with token pilot relief valve backup of the monitor orifice if both the primary seat and monitor seat fail simultaneously.

**CL-31IMRV (See page 6 for Operating Schematic)** - Operation is identical to the 'IMR' except that at no flow position of the monitor orifice a small volume of gas is vented through the relief valve to serve as a signal that the regulator is on monitor operation and the primary seat has failed. No gas is vented until the gas load is less than the volume going through the orifice vent hole and the regulator is on monitor operation.

## Principle of Operation (See Operating Schematic below)

Inlet pressure (tint 1), connected by tubing to the pilot regulator, is utilized as supply pressure for the pilot. Setting of the pilot regulator spring determines the desired outlet pressure (tint 3) of main regulator. Outlet pressure of the pilot regulator is applied to the top of the main diaphragm (B). Loading pressure (tint 2) is a constant pressure equal to the desired outlet pressure plus the pressure required to counterbalance the light closing spring (C). When rate of flow is less than 50 cfh, the only regulator in operation is the pilot regulator. The Main valve (D) is closed any time flow rate is less than that supplied by the pilot regulator (through the bleed orifice (E) between the upper and lower diaphragm case) and the pressure is equalized in both the upper and lower diaphragm chambers (tints 3 and 2). No flow, or lock up pressure, is the outlet pressure required to close the pilot regulator.

reduced and loading pressure (tint 2) above the diaphragm forces the diaphragm downward. This motion is transmitted through the lever (F) to open the main valve (D) to the proper position to match the demand.

### Decreasing Load:

When flow rate is decreased, outlet pressure (tint 3) will increase. This pressure increase decreases the pressure differential across the main diaphragm (B). This allows the closing spring (C) to move the diaphragm upward, closing the main valve (D) and throttling the gas flow.

### Increasing Load:

If the demand for gas is increased, the outlet pressure (tint 3) is

## CL31 Operating Schematic

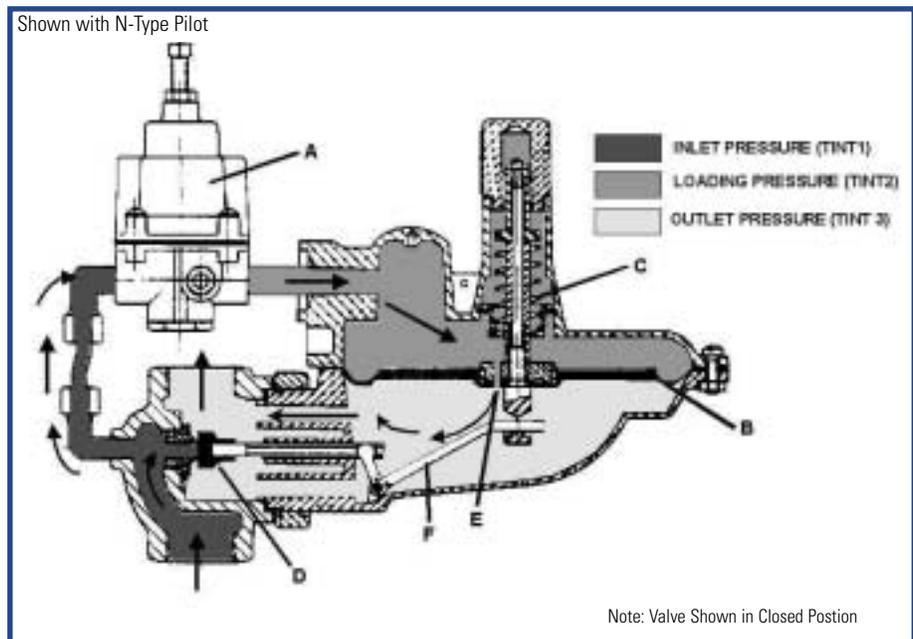

# Specifications

## Construction

Closing Spring:	Music Wire
Valve Body:	High tensile strength cast iron (ASTM A-126, Class A)
Orifice:	Brass (ASTM B16, Alloy 360), Aluminum - optional
Valve Seat:	Buna-N or Silicone (for temperatures below -20 F)
Valve Stem:	Plated steel (Aluminum alloy 2011-T3)
Lever Pin:	Stainless steel (Type 303)
Lever:	Zinc and dichromate plated steel (AISI C1010)
Upper Diaphragm Plate:	Zinc and dichromate plated steel (14 gage steel)
Lower Diaphragm Plate:	Die cast aluminum (ASTM B-85 Alloy SC84A)
Diaphragm:	Buna-N and nylon
Pilot Vent Screen:	Stainless Steel (16 mesh)
Adjustment Ferrule:	Die cast aluminum (ASTM CS43A)
Seal Cap:	Die cast aluminum (ASTM CS43A)
Diaphragm Case:	Die cast aluminum (ASTM B85 -Alloy SC84A)

## Shipping Weight

Four (4) Regulators per box  
Weight per box: 38 lbs.

## Correction factors for non-natural gas applications

The CL31 may be used to control gases other than natural gas. To determine the capacity of the CL31 for gases other than natural gas, it will be necessary to multiply the values within the capacity tables by a correction factor. The table below lists the correction factors for some of the more common gases:

Gas Type	Specific Gravity	Correction Factor (CF)
Air	1.0	0.77
Butane	2.01	0.55
Carbon dioxide (Dry)	1.52	0.63
Carbon monoxide (Dry)	0.97	0.79
Natural gas	0.60	1.00
Nitrogen	0.97	0.79
Propane	1.53	0.63
Propane-air-mix	1.20	0.71

To calculate the correction factor for gases not listed on the table above, it will be necessary to know the specific gravity of the gas and use it in the formula listed below:

$$\text{Correction Factor (CF)} = \sqrt{SG_1/SG_2}$$

Where:

SG<sub>1</sub> = Specific Gravity of the gas in which the capacity is published.

SG<sub>2</sub> = Specific Gravity of the gas to be controlled.

## SPRING RANGE DATA\*

Models CL31R, CL31MR, & CL31MRV

Spring Color	Outlet Pressure Range (psig)
Orange	1.0 to 1.6
Brown	1.6 to 2.6
Green	3.5 to 7.4
Black	3.8 to 13.3
Blue	4.6 to 21.5

Models CL31N & CL31MN

Spring Color	Outlet Pressure Range (psig)
Blue	1-20

\*WARNING: Pilot springs are not interchangeable between N & R Pilots

## ORIFICE DATA – Wide Open Flow Coefficients and Maximum Pressures

Orifice Size	K-Factor	Maximum Operating Inlet Pressure (PSIG)	Maximum Emergency Inlet Pressure (PSIG)	Maximum Emergency Outlet Pressure (PSIG)
1/8"	35	125	175	60
1/8" IM	30	125	175	
3/16"	75	125	175	
3/16" IM	75	125	175	
1/4"	127	125	175	
1/4" IM	120	125	175	
3/8"	290	60	90	
5/16" IM	150	60	90	

For wide-open orifice flow calculations use the following equations:

For  $P_1/P_2 < 1.89$  use:

$$Q = K \sqrt{P_2(P_1 - P_2)}$$

For  $P_1/P_2 > 1.89$  use:  $Q = KP_1^{1/2}$

Where:

$P_1$  = absolute inlet pressure (psia)

$P_2$  = absolute outlet pressure (psia)

Q = flow rate (scfh)

K = orifice coefficient (scfh/psi)

## VALVE BODY SIZES - NPT Thread

Inlet	Outlet
3/4"	3/4"
3/4"	1"
3/4"	1-1/4"
1"	1"
1"	1-1/4"
1-1/4"	1-1/4"

Available Pilot Vent Sizes:

1/4" NPT

Operating Temperature Range:

-20 F to 150 F\*

\*Silicone valve seats available for applications below -20 F.

Loading Ring Position:

0 degrees (Opening aligned with downstream)

Closing Spring (non-adjustable):

Light Green only

Other Available Options:

- Seal wire to indicate unapproved tampering
- 1/8" pipe plug tap on upstream side of valve body
- Pilot supply line filter
- Stainless steel supply line fittings
- Teflon Valve body gasket

## Dimensions

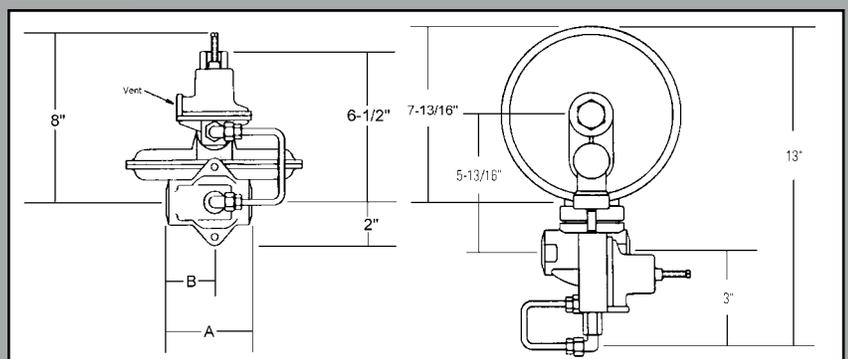

Valve Body Size	A	B
3/4" & 1"	3-3/4	2-1/8
1-1/4"	4	2-1/8

# Capacity Data (1% Absolute Droop)

## Models CL31R & CL31N

(capacities in SCFH of 0.6 S.G. gas; Base condition of 14.7 psia and 60°F)

Inlet Pressure (psig)	Outlet Pressure (psig)	Capacity in SCFH (0.6 S.G. Gas)			
		1/8"	3/16"	1/4"	3/8"
2	1		300	300	500
	2		400	500	905
3	1		325	350	1650
	2		550	850	1650
5	1	325	550	850	1650
	2	275	500	800	1450
10	1	400	825	1450	2550
	2	400	825	1450	2550
	5	400	625	1050	1700
15	1	500	1025	1750	3300
	2	500	1025	1750	3300
	5	500	1025	1700	2750
	10	400	700	1000	1700
20	1	575	1275	2100	3700
	2	575	1275	2100	3700
	5	575	1200	2100	3500
	10	500	1075	1750	3000
	15	400	825	800	1700
30	1	700	1600	2800	4000
	2	700	1600	2800	4000
	5	700	1600	2800	4000
	10	700	1600	2800	4000
	15	700	1450	2100	4000
	20	575	1200	1900	3200
40	1	900	1975	3400	4000
	2	900	1975	3400	4000
	5	900	1975	3400	4000
	10	900	1975	3400	4000
	15	900	1975	3300	4000
	20	900	1850	3300	4000
50	1	1075	2350	4000	4000
	2	1075	2350	4000	4000
	5	1075	2350	4000	4000
	10	1075	2350	4000	4000
	15	1075	2350	4000	4000
	20	1075	2350	4000	4000
60	1	1200	2675	4000	4000
	2	1200	2675	4000	4000
	5	1200	2675	4000	4000
	10	1200	2675	4000	4000
	15	1200	2675	4000	4000
	20	1200	2675	4000	4000
75	1	1400	3150	4000	4000
	2	1400	3150	4000	4000
	5	1400	3150	4000	4000
	10	1400	3150	4000	4000
	15	1400	3150	4000	4000
	20	1400	3150	4000	4000
100	1	1700	4000	4000	Inlet Pressure exceeds Maximum Pressure rating of orifice
	2	1700	4000	4000	
	5	1700	4000	4000	
	10	1700	4000	4000	
	15	1700	4000	4000	
	20	1700	4000	4000	
125	1	2100	4000	4000	Inlet Pressure exceeds Maximum Pressure rating of orifice
	2	2100	4000	4000	
	5	2100	4000	4000	
	10	2100	4000	4000	
	15	2100	4000	4000	
	20	2100	4000	4000	

 Inlet pressure is too low to achieve desired outlet pressure  
 Do not use this orifice at this inlet pressure  
 Note: 3/4" outlet pipe size will limit the capacity to 2000 scfh  
 1" outlet pipe size will limit the capacity to 3000 scfh

# CL31 TYPICAL PERFORMANCE CURVES

## 5 PSIG SET POINT

Type and Model CL31R  
 Inlet Size 1-1/4" NPT  
 Outlet Size 1-1/4" NPT  
 Orifice Size 1/4"

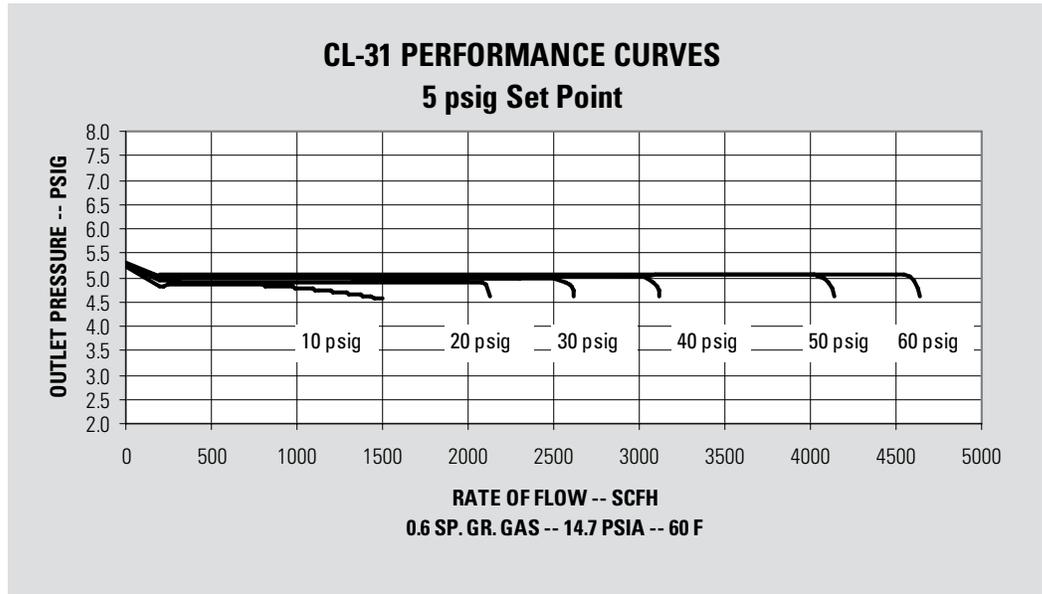

# CL31 TYPICAL PERFORMANCE CURVES

## 10 PSIG SET POINT

Type and Model CL31R  
 Inlet Size 1-1/4" NPT  
 Outlet Size 1-1/4" NPT  
 Orifice Size 1/4"

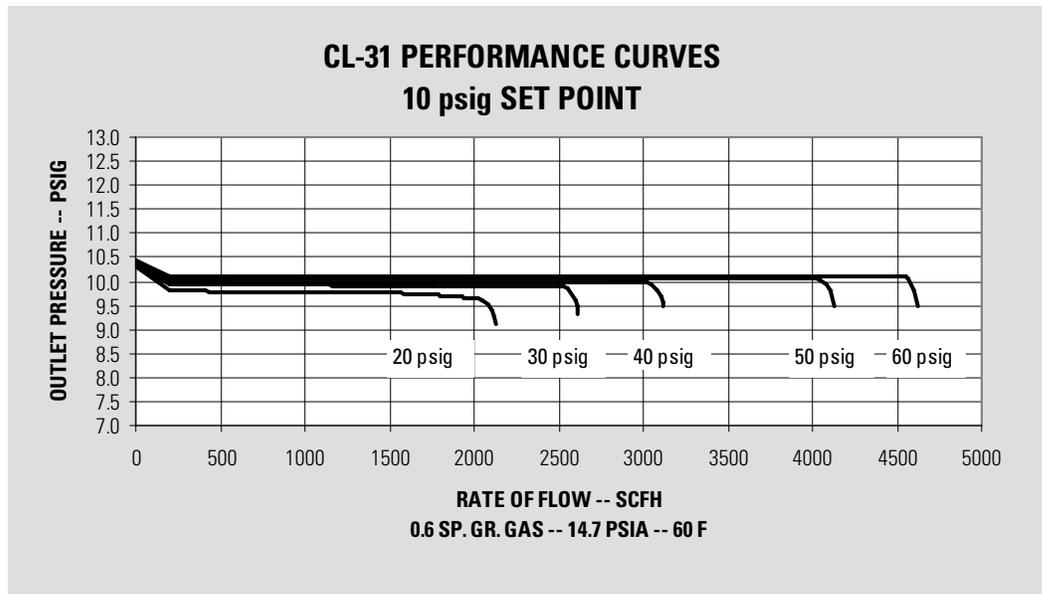

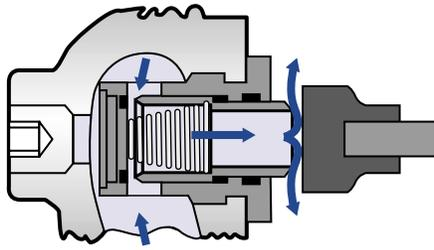

A. Standard Regulator and upstream monitor orifice

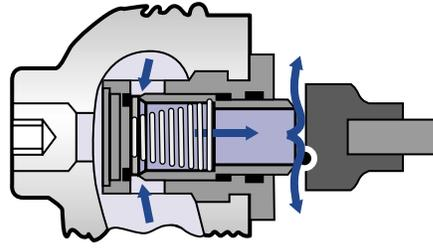

B. Standard Regulator orifice failed; upstream monitor orifice control

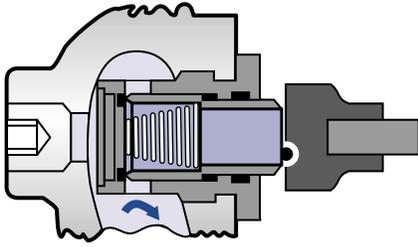

C. Main orifice failed - upstream monitor orifice "lock-up"

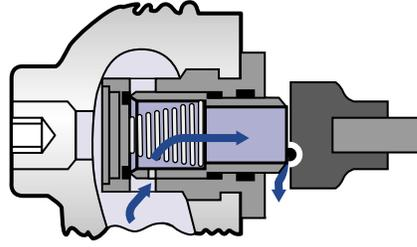

D. "V" Option - Vents small volume of gas to atmosphere through relief valve

□ inlet pressure    ■ outlet pressure

## Principle of Operation

- A. **Normal Operation** - The internal monitor "IM" orifice performs like a standard regulator and monitor regulator in that main orifice and valve seat actuate to control outlet flow and pressure under normal flow conditions. If there is no demand, the main seat AND INTERNAL MONITOR ORIFICE WILL CLOSE.
- B. **Monitor Operation** - If the main valve seat fails to control the gas flow and pressure due to foreign matter between the seat and orifice face, or if the seat is

eroded, the internal monitor orifice automatically goes into operating position at a slightly higher outlet pressure (SEE INTERNAL MONITOR LOCK-UP TABLE). Any time the pressure on the main diaphragm exceeds the force of the fixed monitor spring and the adjusted pressure of the pilot spring, this increase in outlet pressure causes the main valve seat to push against the sliding orifice, compressing the monitor spring and positions the monitor orifice to control the gas flow. The IM orifice now functions as a monitor regulator and will continue to monitor so long as the main seats fails to control at the normal adjusted outlet pressure. However, if the gas load demand is increased beyond the Internal Monitor's capacity, the outlet pressure is reduced to normal adjusted pressure and the regulator resumes normal regulation.

pressure required for Internal Monitor "lock-up" is shown in Internal Monitor Lock-Up Table.

- D. **Vent Hole "V" Option** - On installations where a small volume of over-pressure gas can be safely vented to atmosphere, the advantage of both PILOT relief valve and monitor safety can be combined. If the flow is decreased to zero or just greater than zero, the vent hole in the Internal Monitor orifice allows gas to slowly bleed downstream and cause the pressure to rise to the relief point of the Pilot's internal relief valve. The gas then bleeds to atmosphere indicating a problem with the regulator.

### Internal Monitor Lock-up Pressure\*

Outlet Pressure Set Point (PSIG)	Pilot Spring	IM Lock-Up Pressure (PSIG)
1	ORANGE	1.5
2	BROWN	2.5
5	GREEN	5.6
10	BLACK	10.8
15	BLUE	16.2
20	BLUE	21.2

Note: The above tests were conducted using a 0.1" diameter nylon rod glued to valve seat

- C. **Monitor "Lock-up"** - If the demand for gas is decreased to zero flow during monitor operation, the sliding orifice continues to close until its orifice is in the gas tight position (monitor lock-up) against the BUNA-N monitor valve seat. Outlet

# Capacity Data (1% Absolute Droop)

## Models CL31IMR, CL31IMRV, & CL31IMN

(capacities in SCFH of 0.6 S.G. gas; Base condition of 14.7 psia and 60°F)

		Capacity in SCFH (0.6 S.G. Gas)			
Inlet Pressure (psig)	Outlet Pressure (psig)	1/8"	3/16"	1/4"	3/8"
2	1		300	300	300
3	1		400	475	500
	2		300	325	350
5	1	325	550	675	850
	2	275	500	600	680
10	1	400	825	1050	1250
	2	400	825	1025	1250
	5	400	625	850	1000
15	1	500	1025	1400	1650
	2	500	1025	1375	1650
	5	500	950	1275	1525
	10	400	625	900	1050
20	1	575	1200	1700	2000
	2	575	1200	1700	2000
	5	575	1200	1625	2000
	10	500	1050	1200	1725
	15	400	750	900	1250
30	1	700	1575	2275	2700
	2	700	1575	2275	2700
	5	700	1575	2250	2700
	10	700	1575	2050	2550
	15	700	1450	1900	2275
	20	575	1200	1625	1950
40	1	900	1900	2850	3300
	2	900	1900	2850	3300
	5	900	1900	2850	3300
	10	900	1900	2750	3300
	15	900	1900	2575	3100
	20	900	1775	2500	3000
50	1	1075	2250	3400	4000
	2	1075	2250	3400	4000
	5	1075	2250	3400	4000
	10	1075	2250	3300	4000
	15	1075	2250	3250	4000
	20	1075	2200	3175	4000
60	1	1200	2575	3900	4000
	2	1200	2575	3900	4000
	5	1200	2575	3900	4000
	10	1200	2575	3900	4000
	15	1200	2575	3900	4000
	20	1200	2575	3900	4000
75	1	1400	3075	4000	Inlet Pressure exceeds Maximum Pressure rating of orifice
	2	1400	3075	4000	
	5	1400	3075	4000	
	10	1400	3075	4000	
	15	1400	3075	4000	
	20	1400	3075	4000	
100	1	1700	3600	4000	
	2	1700	3600	4000	
	5	1700	3600	4000	
	10	1700	3600	4000	
	15	1700	3600	4000	
	20	1700	3600	4000	
125	1	2100	4000	4000	
	2	2100	4000	4000	
	5	2100	4000	4000	
	10	2100	4000	4000	
	15	2100	4000	4000	
	20	2100	4000	4000	

Inlet pressure is too low to achieve desired outlet pressure  
Do not use this orifice at this inlet pressure

Note 1: 3/4" outlet pipe size will limit the capacity to 2000 scfh  
1" outlet pipe size will limit the capacity to 3000 scfh

## Installation

- A. Make certain all shipping plugs are removed from the inlet, outlet and vent of any regulator before installation.
- B. When installing the regulator, the inside of the piping and the regulator inlet and outlet are to be clean, free of dirt, pipe dope and other debris to prevent entry into the regulator which could cause loss of pressure control.
- C. The pipe joint sealant should be applied on the male threads of the pipe. Do not use any pipe joint material on the female threads of the regulator or it could become lodged in the regulator causing possible loss of pressure control.
- D. Gas must flow through the valve body of the regulator in the same direction as the arrow cast on the body, or the outlet side of the regulator may be overpressured and damaged.
- E. When the regulator is installed OUTDOORS, the PILOT vent must always be positioned so that rain, snow, moisture or foreign particles cannot enter the vent opening. It is recommended that the PILOT vent be positioned to face downward so as to avoid entry of water or other matter which could interfere with the proper operation of the regulator. For R pilot models, the PILOT vent should be located away from building eaves, windows opening, building air intakes and above the expected snow level at the site. The PILOT vent opening should be inspected periodically to insure it does not become blocked by foreign material.
- F. When the regulator is installed INDOORS, the PILOT vent must be piped to the outside atmosphere while using the shortest length of pipe, the least number of elbows, and having as large a pipe diameter as the vent size or larger. USING VENT PIPE ANY SIZE SMALLER THAN THE VENT CONNECTION WILL LIMIT THE REGULATOR'S PILOT INTERNAL RELIEF VALVE CAPACITY. The outlet end of the pipe must be protected from moisture and the entrance of foreign particles.

## Start-up Procedure

- A. A pressure gauge should be mounted downstream of the regulator to monitor the downstream pressure.
- B. With the downstream valve closed, slowly open the inlet valve. The outlet pressure should rise to slightly greater than the set-point.
- C. Be sure there are no leaks and all connections are tight.
- D. The regulator has been preset at the factory to match specifications given when it was ordered. The outlet pressure may be adjusted by rotating the square-head pilot

adjustment screw. With a small amount of gas flowing through the regulator, rotate the adjustment screw clockwise to raise the outlet pressure and counter-clockwise to lower the outlet pressure.

- E. After the desired outlet pressure is achieved, recheck for leaks, and the regulator is ready for operation.

## SAFETY NOTES:

- A. The maximum inlet pressure for this regulator is dependent upon the size of the orifice and model designation.
- B. When these models are used on liquid petroleum gases, they should be restricted to second-stage pressure reduction in the gaseous phase.

## SAFETY WARNING:

This product, as of the date of manufacture, is designed and tested to conform to all governmental or industry safety standards then existing as may apply to the manufacturer. The purchaser and user of this product are warned that compliance with the manufacturer's instructions and procedures is required in order to avoid the hazards of leaking gas resulting from improper installation, start-up or use of this product, and further, that all area fire control, building codes or other safety regulations established under public laws which regulate or concern the application, installation, operation or general use of this product should be complied with. In order to insure the safe and proper operation of this product, the manufacturer recommends that this product be installed by a qualified installer.

## Ordering Information

Specify:

1. Inlet and Outlet Connection Size and Type
2. Model Number
3. Outlet pressure desired
4. Inlet pressure range
5. Type of gas and maximum capacity required
6. Assembly position number (see chart below)
7. Other Options:
  - Seal wire to indicate unapproved tampering
  - 1/8" pipe plug tap on upstream side of valve body
  - Pilot supply line filter
  - Stainless steel supply line fittings
  - Teflon Valve body gasket

## Warranty

Actaris U.S. Gas, 970 Highway 127 North, Owenton, Kentucky 40359-9802, warrants this gas product against defects in materials and workmanship for the earlier of one (1) year from

the date the product is shipped by Actaris or a period of one year from the date the product is installed by Actaris at the original purchaser's site. During such one-year period, provided that the original purchaser continues to own the product, Actaris will, at its sole option, repair any defects, replace the product or repay the purchase price.

This warranty will be void if the purchaser fails to observe the procedures for installation, operation or service of the product as set forth in the Operating Manual and Specifications for the product or if the defect is caused by tampering, physical abuse or misuse of the product.

Actaris specifically disclaims all implied warranties including those of merchantability or of fitness for a particular purpose. Under no circumstances will Actaris be liable for incidental or consequential damages of any kind whatsoever. The liability for any claim of any kind, including negligence and breach of warranty for the sale and use of any product covered by or furnished, shall in no case exceed the price allocable to the product or part thereof which gives rise to the claim.

## CL31 Assembly Positions

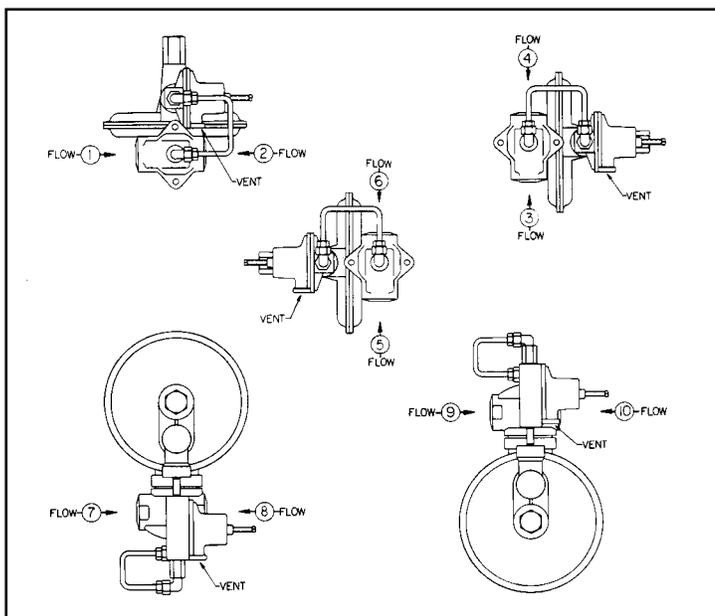

**IMAC Systems, Inc.**  
90 Main Street, PO Box 1605  
Tullytown, PA 19007  
Tel. 1-800-955-4GAS  
(215) 946-2200  
Fax: (215) 943-2984

[www.imacsystems.com](http://www.imacsystems.com)

 **ACTARIS**  
metering systems